

# Spectrum™

## MediaPort 7000

### Component Replacement Guide



---

Manual Part No. 006-0207-001

Copyright © 2015–2016 Harmonic Inc. All rights reserved. Harmonic, the Harmonic logo, Omneon, the Omneon logo, [all other Harmonic products mentioned] are trademarks, registered trademarks or service marks of Harmonic Inc. in the United States and other countries. Dolby, Dolby Digital, Dolby Digital Plus and Dolby E are registered trademarks of Dolby Laboratories. Implementations of AAC and HE-AAC by Fraunhofer IIS. Other company, product and service names mentioned herein may be trademarks or service marks of their respective owners. All product and application features and specifications are subject to change at Harmonic's sole discretion at any time and without notice.

#### Disclaimer

Harmonic reserves the right to alter the equipment specifications and descriptions in this publication without prior notice. No part of this publication shall be deemed to be part of any contract or warranty unless specifically incorporated by reference into such contract or warranty. The information contained herein is merely descriptive in nature, and does not constitute a binding offer for sale of the product described herein. Harmonic assumes no responsibility or liability arising from the use of the products described herein, except as expressly agreed to in writing by Harmonic. The use and purchase of this product do not convey a license under any patent rights, copyrights, trademark rights, or any intellectual property rights of Harmonic. Nothing hereunder constitutes a representation or warranty that using any products in the manner described herein will not infringe any patents of third parties.

#### Third-party product trademarks

Adobe® After Effects®, Photoshop®, Flash® Professional, Premiere®  
Avid®Media Composer®  
Dolby® E, Dolby Digital, Dolby Digital Plus  
Jünger Audio™  
Apple®QuickTime®  
Microsoft® Mediaroom®  
MicrosoftPlayReady®  
DOCSIS®3.0  
Start Over® TV

#### Third-party copyright notes

Dolby is a registered trademark of Dolby Laboratories.  
Dolby Digital, Dolby Digital Plus, Dolby Pulse, aacPlus, AC-3, and Dolby E are trademarks of Dolby Laboratories.  
Level Magic and Jünger are trademarks of Jünger Audio Studioteknik GmbH.  
MPEG Audio technology licensed from Fraunhofer IIS <http://www.iis.fraunhofer.de/amm/>  
PitchBlue® is a registered trademark of Vigor Systems.  
QuickTime and the QuickTime logo are trademarks or registered trademarks of Apple Computer, Inc., used under license therefrom.  
Harmonic software uses version 3.15.4 of the Freemage open source image library under Freemage Public License (FIPL). See <http://freemage.sourceforge.net> for details.

#### Trademark acknowledgments

Harmonic and all Harmonic product names are trademarks of Harmonic. All other trademarks are the property of their respective owners.

The software described in this document is furnished under a license agreement or nondisclosure agreement. The software may be used or copied only in accordance with the terms of those agreements.



May be covered by one or more of U.S. Patents No. 6,571,351; 6,696,996; 6,545,721; 6,574,225; 6,895,003; 6,522,649; 6,643,702; foreign counterparts and pending patent applications.

This system is distributed with certain other software that may require disclosure or distribution of licenses, copyright notices, conditions of use, disclaimers and/or other matter. Use of this system or otherwise fulfilling their conditions constitutes your acceptance of them, as necessary. Copies of such licenses, notices, conditions, disclaimers and/or other matter are available in any one of the following locations: the LEGAL NOTICES AND LICENSES directory of the distribution disk of the software, the root directory of the hard disk drive of the Products, or by contacting us at [support@harmonicinc.com](mailto:support@harmonicinc.com).

#### Notice

Information contained in this guide is subject to change without notice or obligation. While every effort has been made to ensure that the information is accurate as of the publication date, Harmonic Inc. assumes no liability for errors or omissions. In addition, Harmonic Inc. assumes no responsibility for damages resulting from the use of this guide.

#### License agreement and limited warranty

1. **AGREEMENT:** This is a legal agreement ("Agreement") between you ("you" or "your") and Harmonic, or its appropriate local affiliate ("Harmonic", "we", "us" or "our"). Use of our product(s) and any updates thereto purchased or validly obtained by you (the "Products"), and/or the Software (as defined below) (collectively, the "System"), constitutes your acceptance of this Agreement. "Use" includes opening or breaking the seal on the packet containing this Agreement, installing or downloading the Software as defined below or using the Software preloaded or embedded in your





- 
- System. As used herein, the term "Software" means the Harmonic owned software and/or firmware used in or with the Products and embedded into, provided with or loaded onto the Products in object code format, but does not include, and this Agreement does not address, any third-party or free or open source software separately licensed to you ("Third Party Software"). If you do not agree to this Agreement, you shall promptly return the System with a dated receipt to the seller for a full refund.
2. LICENSE: Subject to the terms and conditions of this Agreement (including payment), we hereby grant you a nonexclusive, nontransferable license to use the object code version of the Software embedded into, provided solely for use with or loaded onto the Product, and the accompanying documentation ("Documentation") for your internal business purposes. The Software and any authorized copies are owned by us or our suppliers, and are protected by law, including without limitation the copyright laws and treaties of the U.S.A. and other countries. Evaluation versions of the Software may be subject to a time-limited license key.
  3. RESTRICTIONS: You (and your employees and contractors) shall not attempt to reverse engineer, disassemble, modify, translate, create derivative works of, rent, lease (including use on a timesharing, applications service provider, service bureau or similar basis), loan, distribute, sublicense or otherwise transfer the System, in whole or part except to the extent otherwise permitted by law. The Software may be operated on a network only if and as permitted by its Documentation. You may make one (1) back up copy of the object code of the Software for archival purposes only. Evaluation Software will be run in a lab, nonproductive environment. Results of any benchmark or other performance tests may not be disclosed to any third party without our prior written consent. Title to and ownership of the Software and Documentation, and all copyright, patent, trade secret, trademark, and other intellectual property rights in the System, shall remain our or our licensors' property. You shall not remove or alter any copyright or other proprietary rights notice on the System. We reserve all rights not expressly granted.
  4. LIMITED WARRANTY: (a) Limited Warranty. We warrant to you that, commencing on your receipt of a Product and terminating 1 year thereafter, the System will perform substantially in accordance with its then-current appropriate Documentation. The Product (including replacements) may consist of new, used or previously-installed components. (b) Remedies. If the System fails to comply with such warranty during such period, as your sole remedy, you must return the same in compliance with our product return policy, and we shall, at our option, repair or replace the System, provide a workaround, or refund the fees you paid. Replacement Systems are warranted for the original System's remaining warranty period. (c) Exclusions. EVALUATION SOFTWARE IS LICENSED ON AS-IS BASIS AND SUBJECT TO 4(d). We will have no obligation under this limited warranty due to: (i) negligence, misuse or abuse of the System, such as unusual physical or electrical stress, misuse or accidents; (ii) use of the System other than in accordance with the Documentation; (iii) modifications, alterations or repairs to the System made by a party other than us or our representative; (iv) the combination, operation or use of the System with equipment, devices, software or data not supplied by us; (v) any third party hardware or Third Party Software, whether or not provided by us; (vi) any failure other than by us to comply with handling, operating, environmental, storage or maintenance requirements for the System in the Documentation, including, without limitation, temperature or humidity ranges. (d) Disclaimers. We are not responsible for your software, firmware, information, or data contained in, stored on, or integrated with any Product returned to us for repair or replacement. SUCH LIMITED WARRANTY IS IN LIEU OF, AND WE SPECIFICALLY DISCLAIM, ANY AND ALL OTHER WARRANTIES, WHETHER EXPRESS, IMPLIED OR STATUTORY, INCLUDING, BUT NOT LIMITED TO, ANY IMPLIED WARRANTIES OF SATISFACTORY QUALITY, MERCHANTABILITY, FITNESS FOR A PARTICULAR PURPOSE OR NON-INFRINGEMENT. WE DO NOT WARRANT THAT THE SYSTEM WILL MEET YOUR REQUIREMENTS OR BE UNINTERRUPTED OR ERROR-FREE. NO ADVICE OR INFORMATION, WHETHER ORAL OR WRITTEN, OBTAINED FROM US OR ELSEWHERE, WILL CREATE ANY WARRANTY NOT EXPRESSLY STATED IN THIS AGREEMENT. Some jurisdictions do not allow the exclusion of implied warranties or limitations on how long an implied warranty may last, so such exclusions may not apply to you. In that event, such implied warranties or limitations are limited to 60 days from the date you purchased the System or the shortest period permitted by applicable law, if longer. This warranty gives you specific legal rights and you may have other rights which vary from state to state or country to country.
  5. LIMITATION OF LIABILITY: WE AND OUR AFFILIATES, SUPPLIERS, LICENSORS, OR SALES CHANNELS ("REPRESENTATIVES") SHALL NOT BE LIABLE TO YOU FOR ANY SPECIAL, INCIDENTAL, CONSEQUENTIAL, PUNITIVE, OR EXEMPLARY DAMAGES OF ANY KIND, INCLUDING BUT NOT LIMITED TO LOST REVENUES, PROFITS OR SAVINGS, OR THE COST OF SUBSTITUTE GOODS, HOWEVER CAUSED, UNDER CONTRACT, TORT, BREACH OF WARRANTY, NEGLIGENCE, OR OTHERWISE, EVEN IF WE WERE ADVISED OF THE POSSIBILITY OF SUCH LOSS OR DAMAGES. NOTWITHSTANDING ANY OTHER PROVISIONS OF THIS AGREEMENT, WE AND OUR REPRESENTATIVES' TOTAL LIABILITY TO YOU ARISING FROM OR RELATING TO THIS AGREEMENT OR THE SYSTEM SHALL BE LIMITED TO THE TOTAL PAYMENTS TO US UNDER THIS AGREEMENT FOR THE SYSTEM. THE FOREGOING LIMITATIONS SHALL NOT APPLY TO DEATH OR PERSONAL INJURY TO PERSONS OR TANGIBLE PROPERTY IN ANY JURISDICTION WHERE APPLICABLE LAW PROHIBITS SUCH LIMITATION. YOU ARE SOLELY RESPONSIBLE FOR BACKING UP YOUR DATA AND FILES, AND HEREBY RELEASE US AND OUR REPRESENTATIVES FROM ANY LIABILITY OR DAMAGES DUE TO THE LOSS OF ANY SUCH DATA OR FILES. SOME JURISDICTIONS DO NOT ALLOW THE EXCLUSION OR LIMITATION OF INCIDENTAL OR CONSEQUENTIAL DAMAGES, SO SUCH EXCLUSIONS MAY NOT APPLY TO YOU.
  6. CONFIDENTIALITY: Information in the System and the associated media, as well as the structure, organization and code of the Software, are proprietary to us and contain valuable trade secrets developed or acquired at great expense to us or our suppliers. You shall not disclose to others or utilize any such information except as expressly provided herein, except for information (i) lawfully received by the user from a third party which is not subject to confidentiality obligations; (ii) generally available to the public without breach of this Agreement; (iii) lawfully known to the user prior to its receipt of the System; or (iv) required by law to be disclosed.
  7. SUPPORT: Updates, upgrades, fixes, maintenance or support for the System (an "Upgrade") after the limited warranty period may be available at separate terms and fees from us. Any Upgrades shall be subject to this Agreement, except for additional or inconsistent terms we specify. Upgrades do not extend the limited warranty period.
  8. TERM; TERMINATION: The term of this Agreement shall continue unless terminated in accordance with this Section. We may terminate this Agreement at any time upon default by you of the license provisions of this Agreement, or any other material default by you of this Agreement not cured with thirty (30) days after written notice thereof. You may terminate this Agreement any time by terminating use of the System. Except for the first sentence of Section 2 ("License") and for Section 4(a) ("Limited Warranty"), all provisions of this Agreement shall survive termination of this Agreement. Upon any such termination, you shall certify in writing such termination and non-use to us.
  9. EXPORT CONTROL: You agree that the Products and Software will not be shipped, transferred, or exported into any country or used in any manner prohibited by the United States Export Administration Act or any other export laws, restrictions, or regulations (the "Export Laws"). You will indemnify, defend and hold us harmless from any and all claims arising therefrom or relating thereto. In addition, if the Products or Software are identified as export controlled items under the Export Laws, you represent and warrant that you are not a citizen, or otherwise located within, an embargoed nation (including without limitation Iran, Iraq, Syria, Sudan, Libya, Cuba, North Korea, and Serbia) and that you are not otherwise prohibited under the Export Laws from receiving the Software. All rights to the Products and Software are granted on condition that such rights are forfeited if you fail to comply with the terms of this Agreement.
  10. U.S. GOVERNMENT RIGHTS: The Software and the documentation which accompanies the Software are "Commercial Items," as that term is defined at 48 C.F.R. §2.101, consisting of "Commercial Computer Software" and "Commercial Computer Software Documentation," as such

---

terms are used in 48 C.F.R. §12.212 or 48 C.F.R. §227.7202, as applicable. Consistent with 48 C.F.R. §12.212 or 48 C.F.R. §§227.7202-1 through 227.7202-4, as applicable, the Commercial Computer Software and Commercial Computer Software Documentation are being licensed to U.S. Government as end users (a) only as Commercial Items and (b) with only those rights as are granted to all other end users pursuant to the terms and conditions herein. Harmonic, 4300 North First Street, San Jose, CA 95134, U.S.A.

11. GENERAL: You shall not assign, delegate or sublicense your rights or obligations under this Agreement, by operation of law or otherwise, without our prior written consent, and any attempt without such consent shall be void. Subject to the preceding sentence, this Agreement binds and benefits permitted successors and assigns. This Agreement is governed by California law, without regard to its conflicts of law principles. The U.N. Convention on Contracts for the International Sale of Goods is disclaimed. If any claim arises out of this Agreement, the parties hereby submit to the exclusive jurisdiction and venue of the federal and state courts located in Santa Clara County, California. In addition to any other rights or remedies, we shall be entitled to injunctive and other equitable relief, without posting bond or other security, to prevent any material breach of this Agreement. We may change the terms, conditions and pricing relating to the future licensing of our Systems and other intellectual property rights, including this Agreement, from time to time. No waiver will be implied from conduct or failure to enforce rights nor effective unless in a writing signed on behalf of the party against whom the waiver is asserted. If any part of this Agreement is found unenforceable, the remaining parts will be enforced to the maximum extent permitted. There are no third-party beneficiaries to this Agreement. We are not bound by additional and/or conflicting provisions in any order, acceptance, or other correspondence unless we expressly agree in writing. This Agreement is the complete and exclusive statement of agreement between the parties as to its subject matter and supersedes all proposals or prior agreements, verbal or written, advertising, representations or communications concerning the System. Every reasonable attempt has been made to comply with all licensing requirements for all components used in the system. Any oversight is unintentional and will be remedied if brought to the attention of Harmonic at [support@harmonicinc.com](mailto:support@harmonicinc.com).

In Harmonic documents, special symbols and fonts to call your attention to important information.

-  **DANGER:** The Danger symbol indicates information that, if ignored, can cause physical harm to you.
-  **CAUTION:** The Caution symbol indicates information that, if ignored, can adversely affect the performance of your Harmonic product, or that can make a procedure needlessly difficult.
-  **NOTE:** The Note symbol indicates especially important information you need, or it may provide additional information that applies in only some carefully delineated circumstances.
-  **IMPORTANT:** The Important symbol indicates information that should stand out when you are reading product details and procedural information.
-  **TIP:** The Tip symbol indicates parenthetical information that is not necessary for performing a given procedure, but which, if followed, makes the procedure easier, smoother, or more efficient.

In addition to these symbols, this guide may use the following text conventions:

Convention	Explanation
Typed Command	Indicates the text that you type in at the keyboard prompt.
<Ctrl>, <Ctrl>+<Shift>	A key or key sequence to press.
<a href="http://www.harmonicinc.com">http://www.harmonicinc.com</a>	The italics in blue text to indicate Cross-references, and hyperlinked cross-references in online documents.
<b>Bold</b>	Indicates a button to click, or a menu item to select.
Screen Output	The text that is displayed on a computer screen.
<i>Emphasis</i>	The italics text used for emphasis and document references.

# Table of Contents

---

Chapter 1: Introduction.....	5
Chapter 2: Component replacement.....	6
Bezel replacement.....	6
Removing the bezel.....	6
Installing the bezel.....	7
Power supply replacement.....	8
Replacing the power supply.....	8
ChannelPort or MediaPort module replacement.....	10
Detaching players.....	10
Detaching an I/O module from players.....	11
Changing the MediaPort wink state.....	11
Winking a MediaPort or ChannelPort module.....	11
Removing a module from the chassis.....	12
Deleting an I/O module from SystemManager.....	12
Installing the replacement module.....	13
Attaching an I/O module to existing players.....	13
Activating players.....	13
Verifying functionality.....	14
Chapter 3: Chassis replacement.....	15
Deactivating players.....	15
Removing a MediaPort from SystemManager.....	16
Replacing the chassis.....	16
Changing an I/O module name.....	17
Activating players.....	18
Verifying functionality.....	18
Appendix A: Harmonic Technical Assistance Center contact information.....	19
Harmonic corporate contact information.....	20
Appendix B: Safety and regulatory compliance information.....	21
Important safety instructions.....	21
Safety symbols & translated safety, warning & caution instructions (English).....	22
Symboles de sécurité et traduits de sécurité, d'avertissement et Attention Instructions (français).....	24
Sicherheit Symbole und übersetzt Sicherheit, Achtung & Vorsicht Anleitung (Deutsch).....	27
Site preparation instructions.....	32

Product end-of-life disassembly instructions.....	33
Safety rules (English).....	34
Règles de sécurité.....	34
EU manufacturer's Declaration of Conformity.....	34
Electromagnetic compatibility notices – Class A.....	34
Product regulatory compliance markings.....	37
Product environmental compliance.....	38
EU RoHS.....	39
EU REACH.....	39
China RoHS.....	40
Other RoHS and REACH type regulations.....	41
Waste Electrical and Electronic Equipment (WEEE).....	41
Battery directive.....	41
WEEE Take-Back Request Program.....	42
Compliance with additional country specific environmental, safety and EMC standards:.....	43

# Chapter 1

## Introduction

---

This guide provides information to help you replace components in your Spectrum device or system. Make sure that you read all safety warnings and instructions, and that you have received a replacement component from Harmonic before you begin any of the procedures in this guide.



# MediaPort 7000 component replacement

---

Please contact Technical Support when troubleshooting a component failure. Replacement components are available from Harmonic.

- [Bezel replacement](#)
- [Power supply replacement](#)
- [ChannelPort or MediaPort module replacement](#)

## Bezel replacement

Replacement bezels are available from Harmonic.

 **DANGER:** Observe all conventional ESD precautions when handling Spectrum devices and components.

## Removing the bezel

The bezel may be removed during operation.

1. Remove the center screws on each side of the chassis that secure the bezel to the chassis.
2. Unplug the bezel power/data connector.

 **NOTE:** Keep the rack ear in place.

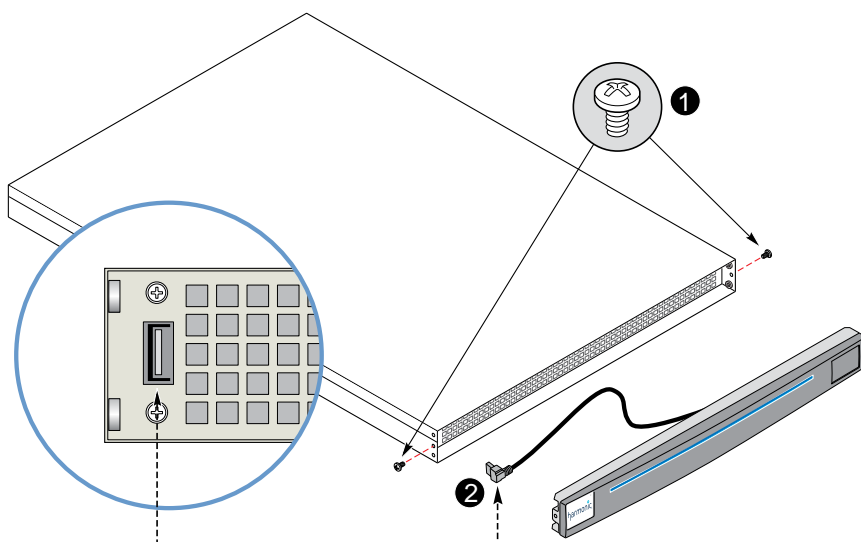

3. Pull the bezel straight away from the chassis.

## Installing the bezel

Align the bezel in front of the chassis so that the Harmonic logo appears on the top left corner.

1. Unpack the new bezel.
2. Attach the bezel power/data connector.
3. Align the bezel in front of the chassis so that the logo appears in the top-left corner, and the metal corners of the bezel are level with the rack ears of the chassis.
4. Keeping the corners aligned, press the bezel straight onto the chassis.
5. Attach the two center screws on each side of the chassis to secure the bezel to the chassis.

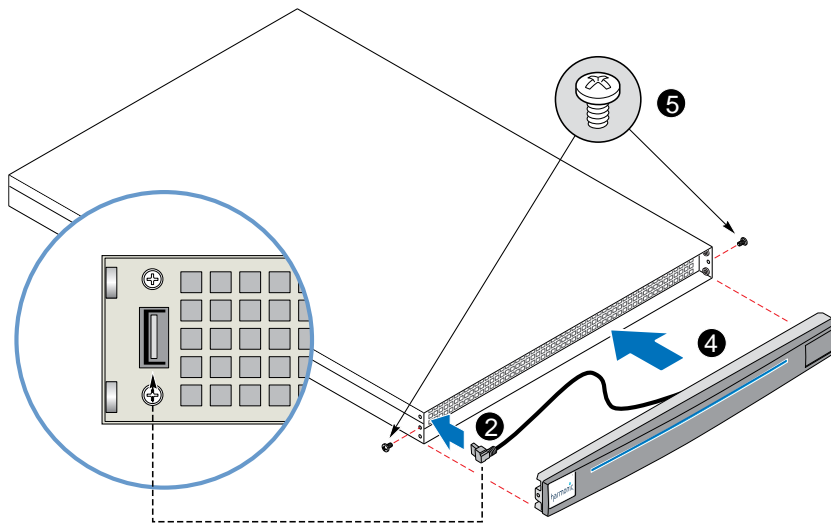

## Power supply replacement

This section provides instructions for replacing a power supply for the MediaPort 7000 chassis.

### Replacing the power supply

The MediaPort 7000 chassis is equipped with two hot-swappable power supplies, each with an independent AC connector. If one power supply fails, the load is transferred to the remaining supply without interruption to service.

#### Before you begin

Unpack the replacement component and inspect for damage. If it is damaged, call Technical Support for assistance and do not continue with this procedure.

To take full advantage of the redundant supplies, Harmonic recommends that you use separate, isolated power sources for each AC input.

**CAUTION:** Observe all conventional ESD precautions when handling MediaPort components.

1. Disconnect the AC power cable.

2. Press the release lever to the right and pull the handle to remove the power supply.

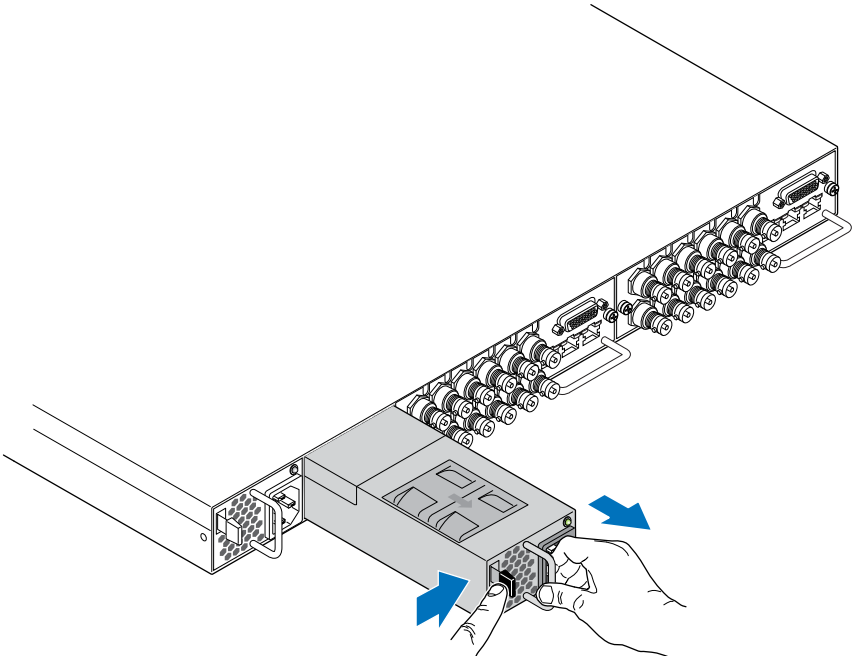

3. Using the handle, slide the power supply into the empty chassis slot. The release lever will click to indicate that the unit is locked in place.

4. Connect the AC power cable.

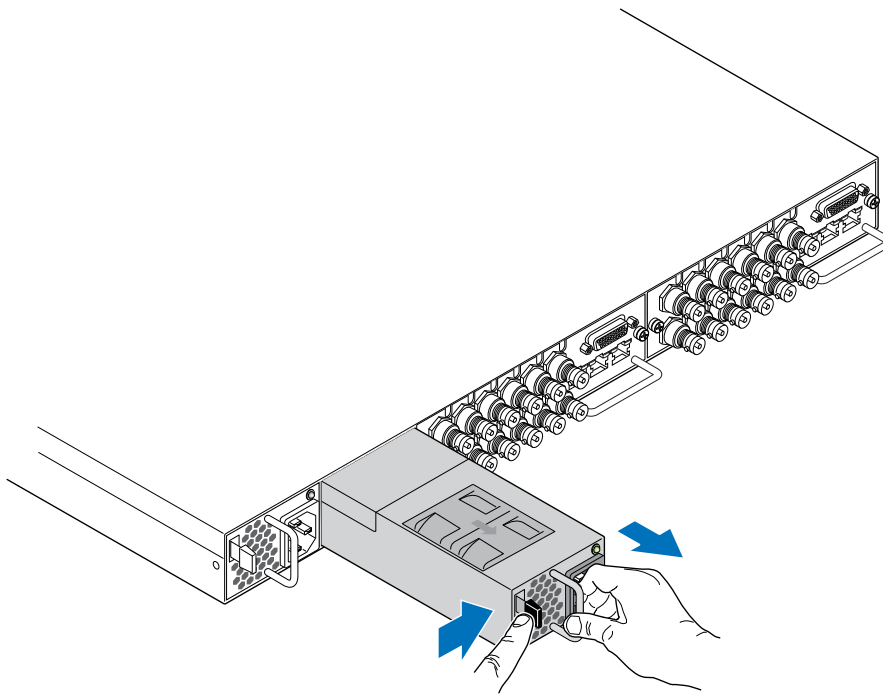

## ChannelPort or MediaPort module replacement

Follow these procedures when replacing a ChannelPort or MediaPort module in the MediaPort 7000.



**NOTE:** The procedures in this section apply to SystemManager version 6.3. If you are running a different version of SystemManager, some steps may vary. Refer to the SystemManager Release Notes for instructions on upgrading.



**DANGER:** Observe all conventional ESD precautions when handling Spectrum devices and components.

## Deactivating players

Deactivate a player when you do not want an automation system to be able to automatically enable the player for play and record.



**NOTE:** In SystemManager, a MediaPort 7000 series appears as two separate MIP-7XXX or CPT-8XXX devices, and a Spectrum X appears as two separate MIP-9XXX devices.

1. Click the **Player Configuration** button in the left-hand column. The **Player Configuration** page appears.
2. Click the icon for the Spectrum server on which the players reside. The **Player List** page appears.

3. Check the box for each Player that you wish to deactivate.
  -  **NOTE:** If replacing a Spectrum server or I/O module, be sure to select all active Players associated with the server or module.
4. Click **Deactivate Selected**.

## Detaching an I/O module from players

Detach a device from players when you wish to replace a MediaPort, ChannelPort, or SDI I/O module.

1. From the **Configuration** tab, click the **Player Configuration** button in the left-hand column. The **Player Configuration** window displays.
2. Click the icon for the Spectrum server on which the players reside. The **Player List** page appears.
3. Find a player associated with the I/O module you wish to replace and click **Edit**. The **Edit Player** page appears.
4. In the **Track** section of the page, click **Attached Devices**. The **Attach Devices** page appears.
5. In the **Attach** column, de-select each device you wish to detach from the player.
6. Click **Done**. The system returns you to **Edit Player** page.
7. Repeat Steps 4-6 to detach devices from another track of the Player associated with the module you are replacing.
8. Repeat this process to detach devices from another Player associated with the module you are replacing.

## Changing the MediaPort wink state

In a system with more than one MediaPort, the wink function can help you identify the MediaPort that needs to be serviced.

On the MediaPort 7000, the wink function activates the light bar on the front panel and the status LED on the back of the processor module.

1. From SystemManager, click the **Configuration** tab to display the **Configuration** page and **System Diagram**.
2. Click the icon for the component you wish to wink. The **Properties** page appears.
3. From the **General Information** section of the page, view the **Wink State**.
  - If currently **Off**, click **Wink On**.
  - If currently **On**, click **Wink Off**.

## Winking a MediaPort or ChannelPort module

In a MediaPort 7000, identify the physical module by changing the wink state in SystemManager. The wink state triggers the status LED on the back of the module.

1. From SystemManager, click the **Configuration** tab to display the **Configuration** page and **System Diagram**.

2. Click the icon for the component you wish to wink.  
The **Properties** page appears.
3. From the **General Information** section of the page, view the **Wink State**.
  - If currently **Off**, click **Wink On**.
  - If currently **On**, click **Wink Off**.

## Removing a module from the chassis

Remove the module from the chassis using a cross-head screwdriver.

1. Disconnect any cables from the module.
2. Using a screwdriver, loosen the two screws on the rear panel of the module as shown.  
The screws are captive and will not come out completely.
3. Using both hands to grip the screws, gently pull out the module from the chassis, as shown in the following figure.

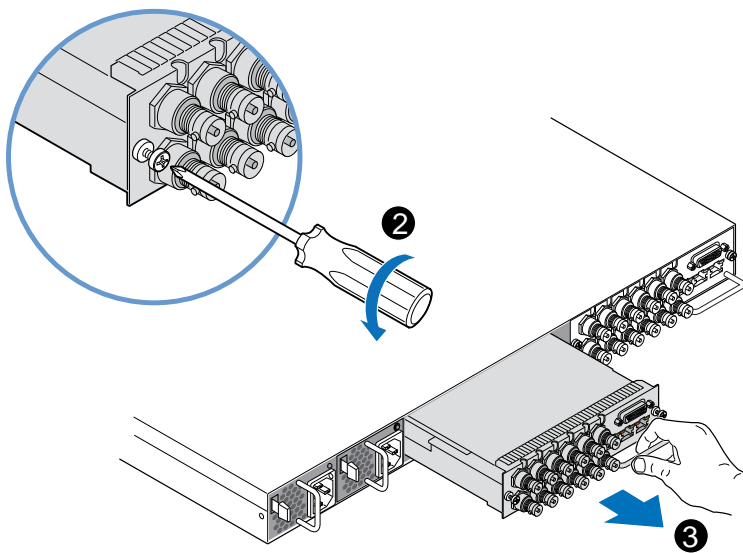

## Deleting an I/O module from SystemManager

Once you have removed the module from the chassis, delete the corresponding I/O module from SystemManager.

1. Click the **Diagnostics** tab to display the **Diagnostics** page.
2. From the **Device Maintenance** section in the left-hand column, click the **Remove Device** icon to display the **Remove Device** page.
3. Scroll to the **I/O Modules** section of the page and locate the module you wish to remove.
4. From the **Select** column, check the box for the I/O module you wish to remove, and then click **Remove**.  
A confirmation message appears.
5. Click **OK**.

After a brief pause, a message appears indicating that the device has been removed (it has also been removed from the **System Diagram**).

6. Click **OK** to return to the **Remove Device** page.

## Installing the replacement module

Secure the module to the chassis using a cross-head screwdriver.

1. Unpack the module.
2. Grasp the module handle and push firmly into the slot. Ensure the module is fully inserted by pressing on the connectors with the palm of your hand.
3. Tighten the two lock screws on the rear panel of the module to secure it to the chassis.
4. From the **Configuration** tab of SystemManager, view the **System Diagram** page and verify that the new module appears.
5. Connect any necessary cables to the module.  
Refer to the *Spectrum System Installation Guide* for instructions.

## Attaching an I/O module to existing players

Use the Attach Devices feature in SystemManager to attach a replacement MediaPort, ChannelPort, or SDI I/O module to existing players.

1. From the **Configuration** tab, click the **Player Configuration** icon in the left-hand column.  
The **Player Configuration** page appears.
2. Click the icon for the Spectrum server on which the players reside.  
The **Player List** page appears.
3. Click the **Edit** link for any player that will use the new module.
4. Within the **Track** section, click the **Attach Devices** button.  
The **Attach Devices** page appears.
5. In the **Attach** column, click the check box for the device that you wish to connect.
6. Click **Done**.

The **Edit Player** page appears. The ID of the new module will appear (in the following format: MIP-7XXX-NNNNN, CPT-8XXX-NNNNN, or MIP-9XXX-NNNNN) next to the attached tracks.

 **TIP:** For help with modifying settings on either the **Edit Player** page or the **Attach Devices** page, refer to “Creating a player” in the *Harmonic SystemManager User Guide*.

7. Click **Done** to return to the **Player List** page.
8. Repeat this procedure for each player that will use the new module.

## Activating players

You may activate Players from the **Player List** page or from the **Edit Player** page.

 **NOTE:** Only one player can be enabled per Playout Channel at a time. If a Player cannot be enabled, an error message appears that details the reasons.

1. From the **Configuration** tab, click the **Player Configuration** button in the left-hand column.  
The **Player Configuration** page displays.



2. From the **Player Configuration** page, click the icon for the Spectrum server on which the players reside.  
The **Player List** window appears, showing a list of players that reside on the selected device and their status.
3. To activate a player from the **Player List** page, check the player(s) you wish to activate, and then select one of the following:

<b>Option</b>	<b>Description</b>
<b>Activate as disabled</b>	Sends the player definition to the Spectrum device. This may be useful if you are using an automation system to automatically enable different players at different times.
<b>Enable</b>	Activates and enables the selected player(s).

4. To activate a player from the **Edit Player** page, do the following:
  - a. For the player you wish to activate, click **Edit**.  
The **Edit Player** page appears.
  - b. To activate the player as disabled, select **Activate as disabled**.
  - c. To activate and enable the player, select **Activate and Enable**.

## Verifying functionality

Harmonic recommends that you verify functionality of the replacement equipment in your Spectrum system before using it on air.

# MediaPort 7000 chassis replacement

---

This section provides instructions for replacing a MediaPort 7000 chassis. Complete the procedures in this section in order.



**CAUTION:** Observe all conventional ESD precautions when handling MediaPort components.



**NOTE:** The procedures in this section apply to SystemManager version 6.3. If you are running a different version, some steps may vary. Refer to the SystemManager Release Notes for instructions on upgrading.

1. [Deactivating players](#)
2. [Removing a MediaPort from SystemManager](#)
3. [Replacing the chassis](#)
4. [Activating players](#)
5. [Verifying functionality](#)

## Deactivating players

Deactivate a player when you do not want an automation system to be able to automatically enable the player for play and record.



**NOTE:** In SystemManager, a MediaPort 7000 series appears as two separate MIP-7XXX or CPT-8XXX devices, and a Spectrum X appears as two separate MIP-9XXX devices.

1. Click the **Player Configuration** button in the left-hand column.  
The **Player Configuration** page appears.
2. Click the icon for the Spectrum server on which the players reside.  
The **Player List** page appears.
3. Check the box for each Player that you wish to deactivate.





**NOTE:** If replacing a Spectrum server or I/O module, be sure to select all active Players associated with the server or module.

4. Click **Deactivate Selected**.

## Removing a MediaPort from SystemManager

Remove a device that is no longer part of your Spectrum system.

1. From the **Diagnostics** tab, click the **Remove Device** icon in the left-hand column.  
The **Remove Device** page appears.
2. If the device you are removing is not responsive, find the device in the **Not Responding Devices** section, select it, and then click **Remove Not Responding Devices**.  
The device is removed (it has also been removed from the **System Diagram**), and this completes the procedure.
3. If you are removing a device that is responsive, follow these steps:
  - a. Click **Stop Monitoring**.  
Once the "Current state of Device Monitoring" changes to **Not monitoring**, continue to the next step.  
 **NOTE:** This may take a few minutes depending on the number of devices in your system.
  - b. Select one or more devices from one of the sections on the page.
  - c. Click **Remove** at the bottom of the section.
  - d. Click **OK** to confirm.  
After a brief pause, a message appears indicating that the device has been removed (it has also been removed from the System Diagram).
  - e. Click **Start Monitoring** to resume device monitoring, and then ensure that the "Current state of Device Monitoring" field changes to **monitoring**.  
 **NOTE:** Device status may show **Not Responding** for a brief interval after monitoring has been turned back on.

## Replacing the chassis

When replacing the chassis, transfer all replaceable components from the old MediaPort to the new MediaPort. Refer to the *Spectrum System Installation Guide* for complete racking instructions.

1. Disconnect any cables from the original MediaPort.
2. Remove the bezel. Refer to "Bezel replacement" in this guide for instructions.
3. Remove the power supplies from the original chassis and install them in the replacement chassis. Refer to "Power supply unit replacement" for instructions.
4. Remove the MediaPort from the rack.
5. Remove the ChannelPort modules from the original chassis and install them in the replacement chassis. Refer to "ChannelPort or MediaPort module replacement" in this guide for instructions.
6. Rack mount the replacement MediaPort. Refer to "Rack mounting instructions" in the *Spectrum System Installation Guide*.
7. Install the bezel on the replacement chassis. Refer to "Bezel replacement" in this guide for instructions.
8. Connect any necessary cables to the MediaPort. Refer to the *Spectrum System Installation Guide* for complete instructions.

 **IMPORTANT:** Before connecting a device to SystemManager, make sure that device monitoring is on. To check device monitoring, click the **Home** tab to open the **Options** page, and view the “Current state of Device Monitoring” field at the top of the page. If the “Current state of Device Monitoring” field displays **NOT monitoring**, then click **Start Monitoring** and wait for the state to change to monitoring before continuing to connect the device. This may take a few minutes depending on the number of devices in your system. Also, note the status of devices may show **Not Responding** for a brief interval after monitoring has been turned on.

9. Power up the MediaPort by plugging in both power cables.
10. On the **System Diagram** page in SystemManager, verify that the new MediaPort appears as **Connected**.
11. In SystemManager, view and clear any alarms that were created after the new MediaPort was connected.  
The replacement MediaPort will appear in SystemManager with the default name. For instructions on changing the name, refer to "Changing an I/O module name" in this guide.
12. Determine the firmware version running on the replacement MediaPort.  
 **NOTE:** All devices in a Spectrum system should be running the same firmware version.
13. If necessary, upgrade firmware on the replacement MediaPort to match that of the rest of your system, and then reboot the MediaPort.
14. Check the status LEDs on the front panel to ensure that the system is operating normally.

## Changing an I/O module name

Renaming can help you identify a MediaPort, ChannelPort, or Spectrum X module while navigating the SystemManager application.

After replacing a MediaPort, the new device appears in SystemManager with the default name.

 **NOTE:** For information about proper naming conventions, please refer to "About Naming Files and System Elements" in the *Harmonic SystemManager User Guide*.

1. From the **System Diagram**, click the icon for the MediaPort that you wish to rename. The **Properties** page appears.
2. At the top of the page, click **Change Name**. The **Change I/O Module Name** page appears.
3. Type the new name in the field provided.
4. Click **Save**. The new name now appears in the **System Diagram**, in various page titles and fields throughout the application.
5. Repeat this procedure to rename another I/O module.

## Activating players

You may activate Players from the **Player List** page or from the **Edit Player** page.



**NOTE:** Only one player can be enabled per Playout Channel at a time. If a Player cannot be enabled, an error message appears that details the reasons.

1. From the **Configuration** tab, click the **Player Configuration** button in the left-hand column. The **Player Configuration** page displays.
2. From the **Player Configuration** page, click the icon for the Spectrum server on which the players reside. The **Player List** window appears, showing a list of players that reside on the selected device and their status.
3. To activate a player from the **Player List** page, check the player(s) you wish to activate, and then select one of the following:

Option	Description
<b>Activate as disabled</b>	Sends the player definition to the Spectrum device. This may be useful if you are using an automation system to automatically enable different players at different times.
<b>Enable</b>	Activates and enables the selected player(s).

4. To activate a player from the **Edit Player** page, do the following:
  - a. For the player you wish to activate, click **Edit**. The **Edit Player** page appears.
  - b. To activate the player as disabled, select **Activate as disabled**.
  - c. To activate and enable the player, select **Activate and Enable**.

## Verifying functionality

Harmonic recommends that you verify functionality of the replacement equipment in your Spectrum system before using it on air.

## Appendix A

### Harmonic Technical Assistance Center contact information

---

A list of phone numbers, e-mail addresses, and important links for the Harmonic Technical Assistance Center (TAC).

Table A-1: Technical Assistance Center phone numbers and email addresses

Region	Telephone Technical Support	Email
Americas	888.673.4896 (888.MPEG.TWO)408.490.6477	<a href="mailto:support@harmonicinc.com">support@harmonicinc.com</a>
Europe, the Middle East and Africa (EMEA)	+44.1252.555.450	<a href="mailto:emeasupport@harmonicinc.com">emeasupport@harmonicinc.com</a>
India	+91.120.498.3199	<a href="mailto:apacsupport@harmonicinc.com">apacsupport@harmonicinc.com</a>
Russia	+7.495.926.4608	<a href="mailto:rusupport@harmonicinc.com">rusupport@harmonicinc.com</a>
China	+86.10.6569.5580	<a href="mailto:chinasupport@harmonicinc.com">chinasupport@harmonicinc.com</a>
Japan	+81.3.5565.6737	<a href="mailto:japansupport@harmonicinc.com">japansupport@harmonicinc.com</a>
Asia Pacific (APAC) – Other Territories	+852.3184.0045 +65.6542.0050	<a href="mailto:apacsupport@harmonicinc.com">apacsupport@harmonicinc.com</a>

Report an issue online

<http://www.harmonicinc.com/webform/report-issue-online>

Harmonic support website

<http://www.harmonicinc.com/content/technical-support>

Software download location for Cable Edge products

<ftp://ftp.harmonicinc.com>

- [Harmonic corporate contact information](#)

## Harmonic corporate contact information

Phone numbers and addresses for the corporate office.

### Harmonic corporate address

4300 North First Street  
San Jose, CA 95134  
U.S.A.

### Harmonic corporate telephone numbers

Tel. 1.800.788.1330 (from the U.S. and Canada)  
Tel. +1.408.542.2500 (outside the U.S. and Canada)  
Fax.+1.408.542.2511

# Safety and regulatory compliance information

---

**Legal disclaimer:** Information in this document is provided in connection with Harmonic products. Unless otherwise agreed in writing Harmonic products are not designed nor intended for any application in which the failure of the product could cause personal injury or death.



**NOTE:** The information in this appendix may apply to purchased products only.

- [\*Important safety instructions\*](#)
- [\*Safety symbols & translated safety, warning & caution instructions \(English\)\*](#)
- [\*Symboles de sécurité et traduits de sécurité, d'avertissement et Attention Instructions \(français\)\*](#)
- [\*Sicherheit Symbole und übersetzt Sicherheit, Achtung & Vorsicht Anleitung \(Deutsch\)\*](#)
- [\*Site preparation instructions\*](#)
- [\*Product end-of-life disassembly instructions\*](#)
- [\*Safety rules \(English\)\*](#)
- [\*Règles de sécurité\*](#)
- [\*EU manufacturer's Declaration of Conformity\*](#)
- [\*Electromagnetic compatibility notices – Class A\*](#)
- [\*Product regulatory compliance markings\*](#)
- [\*Product environmental compliance\*](#)
- [\*Compliance with additional country specific environmental, safety and EMC standards:\*](#)

## Important safety instructions

This section provides important safety guidelines for operators and service personnel. Specific warnings and cautions are found throughout the guide where they apply, but may not appear here. Please read and follow the important safety information, noting especially those instructions related to risk of fire, electric shock or injury to persons. You must adhere to the guidelines in this document to ensure and maintain compliance with existing product certifications and approvals. In this document, we use “product,” “equipment,” and “unit” interchangeably.

This equipment generates, uses, and can radiate radio frequency energy. It may cause harmful interference to radio communications if it is not installed and used in accordance with the instructions in this manual. Operation of this equipment in a residential area is likely to cause harmful interference. If this occurs, the user will be required to correct the interference at his or her own expense.



In event of conflict between the information in this document and information provided with the product or on our website for a particular product, this product documentation takes precedence.









- [Safety symbols \(English\)](#)
- [Symboles de sécurité \(français\)](#)
- [Sicherheit symbole \(Deutsch\)](#)

## Safety symbols & translated safety, warning & caution instructions (English)

To avoid personal injury or property damage, before you begin installing or replacing the product, read, observe, and adhere to all the following safety instructions and information. Harmonic products and/or product packaging may be marked with the safety symbols used throughout this document, when it is necessary to alert operators, users, and service providers to pertinent safety instructions in the manuals.

Mark	Notes
 <p data-bbox="215 942 318 974">Warning</p>	<p data-bbox="464 739 1057 770"><b>Installing or replacing the product unit warning</b></p> <ul data-bbox="464 787 1393 1283" style="list-style-type: none"> <li>• Only trained and qualified service personnel should be allowed to install, replace, or service this unit (refer AS/NZS 3260 Clause 1.2.14.3 Service Personnel).</li> <li>• Read the installation instructions before connecting the system to the power source.</li> <li>• When installing or replacing the unit, always make the ground connection first and disconnect it last.</li> <li>• Installation of the unit must comply with local and national electrical codes.</li> <li>• This unit is intended for installation in restricted access areas. A restricted access area can be accessed only through the use of special tool, lock and key or other means of security.</li> <li>• Use only specified replacement parts.</li> <li>• Do not use this unit in or near water. Disconnect all AC power before installing any options or servicing the unit unless instructed to do so by this manual.</li> </ul>
 <p data-bbox="215 1516 318 1547">Warning</p>	<p data-bbox="464 1312 727 1344"><b>Rack mount warning</b></p> <p data-bbox="464 1360 1373 1423">To prevent bodily injury when mounting or servicing this unit in a rack, special precautions must be taken to ensure your safety and stability of system:</p> <ul data-bbox="464 1440 1386 1633" style="list-style-type: none"> <li>• Conform to local occupational health and safety requirements when moving and lifting the equipment.</li> <li>• Ensure that mounting of the unit by mechanical loading tools should not induce hazardous conditions.</li> <li>• To avoid risk of potential electric shock, a proper safety ground must be implemented for the rack and each piece of equipment installed on it.</li> </ul>



Mark	Notes
 <p data-bbox="215 489 318 520">Warning</p>	<p data-bbox="464 285 678 317"><b>Chassis warning</b></p> <ul data-bbox="464 331 1398 688" style="list-style-type: none"> <li>• Before connecting or disconnecting ground or power wires to the chassis, ensure that power is removed from the DC circuit.</li> <li>• To prevent personal injury or damage to the chassis, lift the unit only by using handles that are an integral part of the chassis, or by holding the chassis underneath its lower edge.</li> <li>• Any instructions in this guide that require opening the chassis or removing a board should be performed by qualified service personnel only.</li> <li>• Slots and openings in the chassis are provided for ventilation. Do not block them. Leave the back of the frame clear for air exhaust cooling and to allow room for cabling - a minimum of 6 inches (15.24 cm) of clearance is recommended.</li> </ul>
 <p data-bbox="215 924 318 955">Warning</p>	<p data-bbox="464 720 756 751"><b>Electric shock warning</b></p> <ul data-bbox="464 766 1406 1791" style="list-style-type: none"> <li>• This unit might have more than one power cord. To reduce the risk of electric shock, disconnect the two power supply cords before servicing the unit.</li> <li>• Before working on a chassis or working near power supplies, unplug the power cord on AC units.</li> <li>• Do not work on the system or connect or disconnect cables during periods of lightning activity.</li> <li>• This unit is grounded through the power cord grounding conductor. To avoid electric shock, plug the power cord into a properly wired receptacle before connecting the product input or outputs.</li> <li>• Route power cords and other cables so that they are not likely to be damaged. Disconnect power input to unit before cleaning. Do not use liquid or aerosol cleaners; use only a damp cloth to clean chassis.</li> <li>• Dangerous voltages exist at several points in this product. To avoid personal injury, do not touch exposed connections and components while power is on. Do not insert anything into either of the system's two power supply cavities with power connected</li> <li>• Never install an AC power module and a DC power module in the same chassis.</li> <li>• Do not wear hand jewelry or watch when troubleshooting high current circuits, such as the power supplies.</li> <li>• To avoid fire hazard, use only the specified correct type voltage and current ratings as referenced in the appropriate parts list for this unit. Always refer fuse replacement to qualified service personnel.</li> <li>• This unit relies on the building's installation for short-circuit (overcurrent) protection. Ensure that a fuse or circuit breaker no larger than 120 VAC, 15A U.S. (240 VAC, 10A international) is used on the phase conductors (all current-carrying conductors).</li> <li>• To avoid electrocution ensure that the rack has been correctly grounded before switching on the unit. When removing the unit remove the grounding connection only after the unit is switched off and unplugged.</li> </ul>

Mark	Notes
 Caution	<p><b>Electrostatic Discharge (ESD) caution</b></p> <ul style="list-style-type: none"> <li>• Follow static precaution at all times when handling this unit.</li> <li>• Always wear an ESD-preventive wrist or ankle strap when handling electronic components. Connect one end of the strap to an ESD jack or an unpainted metal component on the system</li> <li>• Handle cards by the faceplates and edges only; avoid touching the printed circuit board and connector pins.</li> <li>• Place any removed component on an antistatic surface or in a static shielding bag.</li> <li>• Avoid contact between the cards and clothing.</li> <li>• Periodically check the resistance value of the antistatic strap. Recommended value is between 1 and 10 mega-ohms (Mohms).</li> </ul>
 Warning	<p><b>Laser radiation warning</b></p> <p>Invisible laser radiation may be emitted from disconnected fibers or connectors. Do not stare into beams or view directly with optical instruments. Never operate a unit with a broken fibre or with a separated fiber connector.</p>
 Warning	<p><b>Lithium battery handling safety instructions</b></p> <ul style="list-style-type: none"> <li>• CALIFORNIA PERCHLORATE ADVISORY: Some lithium batteries may contain perchlorate material. The following advisory is provided: "Perchlorate Material - special handling may apply, see: <a href="http://www.dtsc.ca.gov/hazardouswaste/perchlorate/">http://www.dtsc.ca.gov/hazardouswaste/perchlorate/</a> for information."</li> </ul>
 Caution	<ul style="list-style-type: none"> <li>• Risk of explosion if battery is replaced incorrectly or with an incorrect type</li> <li>• Dispose of used batteries according to the manufacturer's instructions</li> <li>• There are no user-serviceable batteries inside Harmonic products. Refer to Harmonic qualified personnel only to service the replaceable batteries</li> </ul>





## Symboles de sécurité et traduits de sécurité, d'avertissement et Attention Instructions (français)

Pour éviter des blessures ou des dommages matériels, avant de commencer l'installation ou le remplacement du produit, lire, observer, et de respecter toutes les instructions et informations de sécurité suivantes. Produits harmoniques et / ou l'emballage du produit peuvent être marqués avec les symboles

de sécurité utilisés dans le présent document, lorsque cela est nécessaire pour alerter les opérateurs, les utilisateurs et les fournisseurs de services de consignes de sécurité pertinentes dans les manuels.

Mark	Notes
 <p data-bbox="215 569 386 594">Avertissement</p>	<p data-bbox="464 363 1279 388"><b>Installation ou remplacement de l'unité de produit avertissement</b></p> <ul data-bbox="464 411 1398 999" style="list-style-type: none"> <li>• Il est vivement recommandé de confier l'installation, le remplacement et la maintenance de ces équipements à des personnels qualifiés et expérimentés. (voir AS / NZS 3260 article 1.2.14.3 du personnel de service).</li> <li>• Avant de brancher le système sur la source d'alimentation, consulter les directives d'installation.</li> <li>• Lors de l'installation ou le remplacement de l'appareil, la mise à la terre doit toujours être connectée en premier et déconnectée en dernier.</li> <li>• L'équipement doit être installé conformément aux normes électriques nationales et locales.</li> <li>• Cet appareil est à installer dans des zones d'accès réservé. Ces dernières sont des zones auxquelles seul le personnel de service peut accéder en utilisant un outil spécial, un mécanisme de verrouillage et une clé, ou tout autre moyen de sécurité.</li> <li>• Utilisez uniquement des pièces de rechange spécifiées.</li> <li>• Ne pas utiliser ce produit dans l'eau ni à proximité de l'eau. Débrancher toutes les prises d'alimentation secteur avant d'installer des options ou d'effectuer l'entretien de l'unité, à moins d'instructions contraires dans le présent manuel.</li> </ul>
 <p data-bbox="215 1241 386 1266">Avertissement</p>	<p data-bbox="464 1035 829 1060"><b>Rack monture avertissement</b></p> <p data-bbox="464 1083 1357 1171">Pour éviter les blessures corporelles lors du montage ou l'entretien de cet appareil dans un rack, des précautions particulières doivent être prises pour assurer votre sécurité et la stabilité du système:</p> <ul data-bbox="464 1194 1390 1388" style="list-style-type: none"> <li>• Conformez-vous aux exigences de médecine du travail et de sécurité lorsque vous déplacez et soulevez le matériel.</li> <li>• Assurez-vous que le montage de l'appareil par des outils de chargement mécaniques ne doit pas induire des conditions dangereuses.</li> <li>• Pour éviter tout risque d'électrocution, le rack et chaque élément de l'équipement installé dans le rack doivent être correctement reliés à la terre.</li> </ul>
 <p data-bbox="215 1625 386 1650">Avertissement</p>	<p data-bbox="464 1419 756 1444"><b>Châssis avertissement</b></p> <ul data-bbox="464 1467 1398 1850" style="list-style-type: none"> <li>• Avant de connecter ou de déconnecter les câbles d'alimentation (pôles et terre) du châssis, vérifiez que le circuit de courant continu est hors tension.</li> <li>• Pour éviter toute blessure ou des dommages au châssis, soulevez l'unité uniquement par les poignées du châssis lui-même ou en portant celui-ci par le bord inférieur.</li> <li>• Toutes les opérations du présent guide nécessitant l'ouverture du châssis ou le retrait d'une carte doivent être uniquement effectuées par du personnel d'entretien qualifié.</li> <li>• Le châssis est muni de fentes et d'ouvertures d'aération. Ne pas les bloquer. Dégager l'arrière du cadre pour permettre le refroidissement de l'évacuation d'air et laisser de la place au câblage; un dégagement d'au moins 15.24 cm (6 po) est recommandé.</li> </ul>



Mark	Notes
 <p data-bbox="215 489 386 514">Avertissement</p>	<p data-bbox="467 283 850 308"><b>Choc électrique avertissement</b></p> <ul data-bbox="467 331 1403 1539" style="list-style-type: none"><li data-bbox="467 331 1403 422">• Il est possible que cette unité soit munie de plusieurs cordons d'alimentation. Pour éviter les risques d'électrocution, débrancher les deux cordons d'alimentation avant de réparer l'unité.</li><li data-bbox="467 432 1403 522">• Avant de travailler sur un châssis ou à proximité d'une alimentation électrique, débrancher le cordon d'alimentation des unités en courant alternatif.</li><li data-bbox="467 533 1403 590">• Ne pas travailler sur le système ni brancher ou débrancher les câbles pendant un orage.</li><li data-bbox="467 600 1403 722">• Ce unité est mis à la terre par le conducteur de protection intégré au cordon d'alimentation. Pour éviter les chocs électriques, brancher le cordon d'alimentation dans une prise correctement cable avant de raccorder les entrées ou sorties du unité.</li><li data-bbox="467 732 1403 854">• Installer les cordons d'alimentation et autres cables de sorte qu'ils ne risquent pas d'être endommagés. Couper l'alimentation avant nettoyage. Ne pas utiliser de nettoyant liquide ou en aérosol; utiliser seulement un linge humide.</li><li data-bbox="467 865 1403 987">• Des courants électriques dangereux circulent dans cet appareil. Afin d'éviter les lessures, ne pas toucher les connexions et composants exposés lorsque l'appareil est sous tension. Ne rien insérer dans l'une ou l'autre des cavités des prises de courant du système lorsque l'appareil est sous tension.</li><li data-bbox="467 997 1403 1054">• N'installez jamais un module d'alimentation AC et un module d'alimentation DC dans le même châssis.</li><li data-bbox="467 1064 1403 1121">• Ne pas porter de bijoux aux mains ni de montre durant le dépannage des circuits à haute tension, comme les transformateurs.</li><li data-bbox="467 1131 1403 1253">• Pour prévenir les risques d'incendie, n'utiliser que le type, la tension et le courant nominal spécifiés dans la nomenclature des pièces de ce unité. Toujours confier le remplacement des fusibles à du personnel d'entretien qualifié.</li><li data-bbox="467 1264 1403 1413">• Pour ce qui est de la protection contre les courts-circuits (surtension), ce produit dépend de l'installation électrique du local. Vérifier qu'un fusible ou qu'un disjoncteur de 120 V alt., 15 A U.S. maximum (240 V alt., 10 A international) est utilisé sur les conducteurs de phase (conducteurs de charge).</li><li data-bbox="467 1423 1403 1545">• Pour éviter l'électrocution, assurez-vous que le rack a bien été mis à la terre avant de mettre l'unité en marche. Lors du retrait de l'unité, retirer le raccordement de terre seulement après avoir mis l'unité à l'arrêt et l'avoir débranchée.</li></ul>

Mark	Notes
 <p data-bbox="215 489 321 516">Attention</p>	<p data-bbox="464 285 1062 312"><b>Les décharges électrostatiques (ESD) attention</b></p> <ul data-bbox="464 331 1398 758" style="list-style-type: none"> <li>• Respecter systématiquement les précautions relatives aux charges électrostatiques durant la manipulation de cet unité.</li> <li>• Portez toujours un poignet ou la cheville bracelet antistatique préventive lors de la manipulation des composants électroniques. Branchez une extrémité de la sangle à une prise ESD ou d'un composant métallique non peinte sur le système.</li> <li>• Manipulez les cartes en les faces avant et les bords seulement; éviter de toucher la carte de circuit imprimé et les broches du connecteur.</li> <li>• Placer un composant retiré sur une surface antistatique ou dans un sac de protection statique.</li> <li>• Éviter tout contact entre les cartes et les vêtements.</li> <li>• Vérifier périodiquement la valeur de résistance de la sangle antistatique. Valeur recommandée est comprise entre 1 et 10 méga-ohms (Mohms).</li> </ul>
 <p data-bbox="215 993 386 1020">Avertissement</p>	<p data-bbox="464 789 829 816"><b>Rayonnement laser attention</b></p> <p data-bbox="464 835 1403 961">Rayonnement laser invisible peut être émis à partir de fibres ou les connecteurs débranchés. Ne pas regarder en faisceaux ou regarder directement avec des instruments optiques. Ne jamais faire fonctionner une unité en cas de bris d'une fibre ou de séparation d'un connecteur de fibre.</p>
 <p data-bbox="215 1260 386 1287">Avertissement</p>	<p data-bbox="464 1056 1175 1083"><b>Batterie au lithium manipulation instructions de sécurité</b></p> <ul data-bbox="464 1102 1393 1228" style="list-style-type: none"> <li>• Perchlorate pour la Californie Consultatif: Certaines batteries au lithium, peuvent contenir du perchlorate. le texte qui suit consultatif est prévu: "Présence de perchlorate - une manipulation spéciale peut s'appliquer, voir: <a href="http://www.dtsc.ca.gov/hazardouswaste/perchlorate/">http://www.dtsc.ca.gov/hazardouswaste/perchlorate/</a> for information."</li> </ul>
 <p data-bbox="215 1526 321 1554">Attention</p>	<ul data-bbox="464 1331 1403 1556" style="list-style-type: none"> <li>• Il y a danger d'explosion si la batterie est remplacée de manière incorrecte ou par une batterie de type incorrect.</li> <li>• Mettre au rebut les batteries usagées conformément aux instructions du fabricant.</li> <li>• Les batteries des produits Harmonic ne peuvent pas être réparées ni entretenues par l'utilisateur. Ne confier l'entretien des batteries remplaçables qu'à du personnel compétent de Harmonic.</li> </ul>

## Sicherheit Symbole und übersetzt Sicherheit, Achtung & Vorsicht Anleitung (Deutsch)

Um Verletzungen oder Sachschäden zu vermeiden, bevor Sie mit der Installation oder Austausch des Produkts zu beginnen, zu lesen, zu beobachten, und sich an all den folgenden Sicherheitshinweise und





Informationen. Harmonic Produkte und / oder Produktverpackungen können mit den Sicherheitssymbolen in diesem Dokument verwendet werden, markiert, wenn es notwendig ist für die Betreiber, Anwender und Dienstleister, um relevante Sicherheitsanweisungen in den Handbüchern zu alarmieren.

Mark	Notes
 <p data-bbox="215 600 326 632">Warnung</p>	<p data-bbox="464 394 1260 426"><b>Installation oder den Austausch des Produkts Einheit Warnung</b></p> <ul data-bbox="464 443 1393 968" style="list-style-type: none"> <li>• Das Installieren, Ersetzen oder Bedienen dieser Ausrüstung sollte nur geschultem, qualifiziertem Personal gestattet werden (siehe AS / NZS 3260 Clause 1.2.14.3 Servicepersonal)</li> <li>• Lesen Sie die Installationsanweisungen, bevor Sie das System an die Stromquelle anschließen.</li> <li>• Der Erdanschluß muß bei der Installation der Einheit immer zuerst hergestellt und zuletzt abgetrennt werden.</li> <li>• Die Installation der Geräte muss den Sicherheitsstandards entsprechen.</li> <li>• Diese Einheit ist zur Installation in Bereichen mit beschränktem Zutritt vorgesehen. Ein Bereich mit beschränktem Zutritt ist ein Bereich, zu dem nur Wartungspersonal mit einem Spezialwerkzeugs, Schloß und Schlüssel oder anderer Sicherheitsvorkehrungen Zugang.</li> <li>• Verwenden Sie nur die angegebenen Ersatzteile</li> <li>• Das Gerät in oder in der Nähe von Wasser verwenden. Trennen Sie vor der Installation von Optionen oder Wartung des Gerätes, es sei denn, dies wurde von diesem Handbuch alle Netz.</li> </ul>
 <p data-bbox="215 1205 326 1236">Warnung</p>	<p data-bbox="464 999 773 1031"><b>Rack-Montage-Warnung</b></p> <p data-bbox="464 1050 1344 1142">Zur Vermeidung von Körperverletzung beim Anbringen oder Warten dieser Einheit in einem Gestell müssen Sie besondere Vorkehrungen treffen, um sicherzustellen, daß das System stabil bleibt:</p> <ul data-bbox="464 1161 1398 1388" style="list-style-type: none"> <li>• Entsprechen den lokalen Arbeitsschutzanforderungen beim Bewegen und Heben der Ausrüstung.</li> <li>• Stellen Sie sicher, dass die Montage des Gerätes durch mechanische Belastung Werkzeuge sollten nicht gefährlichen Bedingungen zu induzieren.</li> <li>• Um das Risiko von möglichen elektrischen Schlag zu vermeiden, muss mit einer angemessenen Erdung für Rack und jedes Gerät installiert ist implementiert werden.</li> </ul>

Mark	Notes
 <p data-bbox="215 489 326 520">Warnung</p>	<p data-bbox="464 285 691 317"><b>Chassis Warnung</b></p> <ul data-bbox="464 331 1393 789" style="list-style-type: none"><li data-bbox="464 331 1393 426">• Gleichstrom-Unterbrechung Bevor Sie Erdungs- oder Stromkabel an das Chassis anschließen oder von ihm abtrennen, ist sicherzustellen, daß der Gleichstrom-Stromkreis unterbrochen ist.</li><li data-bbox="464 432 1393 558">• Um Verletzungen und Beschädigung des Chassis zu vermeiden, sollten Sie das Chassis nicht an den Henkeln auf den Elementen (wie z.B. Stromanschlüsse, Kühlungen oder Karten) heben oder kippen; oder indem Sie es unterhalb der Unterkante packen.</li><li data-bbox="464 564 1393 659">• Alle Hinweise in diesem Handbuch, die das Öffnen benötigen Sie das Gehäuse oder das Entfernen eines Board sollte nur von qualifiziertem Fachpersonal durchgeführt werden.</li><li data-bbox="464 665 1393 789">• Für Schlitze und Öffnungen im Chassis vorgesehen. Blockieren Sie sie nicht. Lassen Sie die Rückseite des Rahmens frei für Abluftkühlung und um Platz für die Verkabelung ermöglichen - ein Minimum von 6 Zoll (15,24 cm) Abstand wird empfohlen</li></ul>



Mark	Notes
 <p data-bbox="215 489 326 520">Warnung</p>	<p data-bbox="464 285 773 317"><b>Elektroschock-Warnung</b></p> <ul data-bbox="464 331 1398 1516" style="list-style-type: none"> <li>• Diese Einheit hat möglicherweise mehr als ein Netzkabel. Zur Verringerung der Stromschlaggefahr trennen Sie beide Netzgerätekabel ab, bevor Sie die Einheit warten.</li> <li>• Vor der Arbeit an einem Chassis für Arbeiten in der Nähe Stromversorgung, ziehen Sie das Netzkabel mit Netzeinheiten.</li> <li>• Arbeiten Sie nicht am System und schließen Sie keine Kabel an bzw. trennen Sie keine ab, wenn es gewittert.</li> <li>• Dieses Gerät ist über das Netzkabel Erdungsleiter geerdet. Um einen Stromschlag zu vermeiden, stecken Sie das Netzkabel in eine Steckdose richtig verdrahtet, bevor Sie das Produkt Eingang oder Ausgänge.</li> <li>• Verlegen Sie Netzkabel und andere Kabel, so dass sie wahrscheinlich nicht beschädigt werden. Trennen Eingangsleistung Einheit vor der Reinigung. Verwenden Sie keine flüssigen oder Aerosolreiniger; nur mit einem feuchten Tuch zu reinigen Chassis.</li> <li>• Gefährliche Spannungen vorhanden sind an mehreren Stellen in diesem Produkt. Um Verletzungen zu vermeiden, berühren Sie nicht freiliegenden Anschlüsse und Komponenten während schaltet ist. Sie keine Gegenstände in einem der beiden Stromversorgungs Hohlräume des Systems mit Strom verbunden einführen.</li> <li>• Ein Wechselstromsmodul und ein Gleichstrommodul dürfen niemals in demselben Chassis installiert werden.</li> <li>• Tragen Sie keine Hand Schmuck oder schauen Sie bei der Fehlersuche hohen Stromkreise, wie beispielsweise die Stromversorgung.</li> <li>• Um die Brandgefahr zu vermeiden, verwenden Sie nur den genannten richtige Art von Spannung und Strom Ratings als in der entsprechenden Stückliste für diese Einheit verwiesen. Beziehen sich immer auf Austausch der Sicherung von qualifiziertem Fachpersonal.</li> <li>• Dieses Produkt ist darauf angewiesen, daß im Gebäude ein Kurzschluß- bzw. Überstromschutz installiert ist. Stellen Sie sicher, daß eine Sicherung oder ein Unterbrecher von nicht mehr als 240 V Wechselstrom, 10 A (bzw. in den USA 120 V Wechselstrom, 15 A) an den Phasenleitern (allen stromführenden Leitern) verwendet wird.</li> <li>• Um einen Stromschlag zu vermeiden, sicherzustellen, dass die Zahnstange wurde korrekt vor dem Einschalten des Gerätes geerdet. Beim Entfernen der Einheit entfernen Sie die Masseverbindung nur, nachdem das Gerät ausgeschaltet und der Netzstecker gezogen.</li> </ul>

Mark	Notes
 <p>Vorsich</p>	<p><b>Elektrostatische Entladung (ESD) Vorsicht</b></p> <ul style="list-style-type: none"> <li>• Folgen Sie statische vorsorglich zu jeder Zeit beim Umgang mit diesem Gerät.</li> <li>• Tragen Sie immer einen ESD-präventive Handgelenk oder Knöchel-Riemen beim Umgang mit elektronischen Komponenten. Schließen Sie ein Ende des Bandes an einem ESD-Buchse oder ein unlackiertes Metallteil auf dem System.</li> <li>• Hand Karten nur durch die Faceplates und Kanten; Berühren Sie die bedruckte Leiterplatte und Steckerstifte.</li> <li>• Legen Sie alle entfernten Komponenten auf eine antistatische Oberfläche oder in einem Statik-Beutel.</li> <li>• Kontakt zwischen den Karten und Kleidung vermeiden.</li> <li>• Den Widerstandswert der gegen statische Gurt in regelmäßigen Abständen überprüfen. Empfohlener Wert ist zwischen 1 und 10 Mega-Ohm (MOhm).</li> </ul>
 <p>Warnung</p>	<p><b>Laserstrahlungen Warnung.</b></p> <p>Unsichtbare Laserstrahlung kann von getrennten Fasern oder Stecker emittiert werden. Nicht in die Strahlen blicken oder direkt mit optischen Instrumenten. Niemals ein Gerät mit einem gebrochenen Faser oder mit einem Glasfaseranschluss getrennt.</p>
 <p>Warnung</p>	<p><b>Lithium-Batterie Handhabung Sicherheitshinweise</b></p> <ul style="list-style-type: none"> <li>• CALIFORNIA PERCHLORATE ADVISORY: Einige Lithium-Batterien kann Perchlorat enthalten. Die folgende Beratungs gesetz: "Perchlorat - Sonderbehandlung kann erforderlich sein, finden Sie unter: <a href="http://www.dtsc.ca.gov/hazardouswaste/perchlorate/">http://www.dtsc.ca.gov/hazardouswaste/perchlorate/</a> for information."</li> </ul>
 <p>Vorsich</p>	<ul style="list-style-type: none"> <li>• Bei Einsetzen einer falschen Batterie besteht Explosionsgefahr</li> <li>• Entsorgen Sie die benutzten Batterien nach den Anweisungen des Herstellers.</li> <li>• Es gibt keine zu wartenden Akkus im Harmonic Produkte. Siehe Harmonic qualifiziertes Personal, um die austauschbare Batterien Service</li> </ul>

## Site preparation instructions

Make the equipment site ready for installation and use.



**NOTE:** Only trained and qualified service personnel (as defined in IEC 60950 and AS/NZS 3260) should install, replace, or service the equipment. Install the system in accordance with the U.S. National Electric Code if you are in the United States.

### 1. Preparing & choosing a site for installation

- To ensure normal system operation, plan your site configuration and prepare the site before installation.
- Install the unit in a restricted access area.
- Choose a site with a dry, clean, well-ventilated and air-conditioned area.
- Choose a site that maintains an ambient temperature of 32 to 104oF (0 to 40oC)

### 2. Creating a safe environment

- Connect AC-powered systems to grounded power outlets or as per local regulations.
- Do not move or ship equipment unless it is correctly packed in its original wrapping and shipping containers.
- Only allow Harmonic trained personnel to undertake equipment service and maintenance. Do not permit unqualified personnel to operate the unit.
- Wear ear protection when working near an NSG Pro platform for a longer period of time.

### 3. Rack mounting the unit

- Install the system in an open rack whenever possible. If installation in an enclosed rack is unavoidable, ensure that the rack has adequate ventilation.
- Reliable earthing of rack-mounted equipment should be maintained. Particular attention should be given to supply connections other than direct connections to the branch circuit (e.g. use of power strips). This unit should be mounted at the bottom of the rack if it is the only unit in the rack.
- When mounting this unit in the partially filled rack, load the rack from the bottom to the top with the heaviest component at the bottom of the rack.
- If the rack is provided with stabilizing devices, install the stabilizers before mounting or servicing the unit in the rack.
- The rack must be anchored to an immovable support to prevent it from tipping when the unit is mounted on it. The rack must be installed according to the rack manufacturer's instructions.
- Disconnect all power and external cables before lifting the unit. Depending on the weight of the unit, more than one person might be required to lift it.

### 4. Power considerations

#### Option

#### AC power

#### Description

- Adding to the system a UPS (Uninterrupted Power Supply) and an AVR (Automated Voltage Regulator) is highly recommended.
- Installing the main power supply by a qualified electrician, according to power authority regulations. Make sure all powering are wired with an earth leakage, according to local regulations.

Option	Description
DC power	<ul style="list-style-type: none"> <li>◦ It is recommended to install the encoder within 1.5m (approximately 5 feet) from an easily accessible grounded AC outlet.</li> <li>◦ When the encoder is rack-mounted, ensure that the rack is correctly grounded.</li> <li>◦ Ensure a suitable overcurrent device is in-line between the equipment and the power source.</li> <li>◦ Connect DC-input power supplies only to a DC power source that complies with the safety extra-low voltage (SELV) requirements in the UL60950-1, CAN/CSA-C22.2 No. 60950-1-03, AS/NZS 60950-1, EN/IEC 60825-1, 21 CFR 1040, EN 60950-1, and IEC 60950-1 standards.</li> <li>◦ Ensure that power is removed from the DC circuit before installing or removing power supplies</li> </ul>
5. Handling Fiber Channel cables	<ul style="list-style-type: none"> <li>◦ Always read and comply with the handling instructions on the shipping container.</li> <li>◦ Follow all ESD precautions and approved fiber cleaning procedures.</li> <li>◦ The fiber is made of a very pure, expensive glass and should be treated with great care. Handle fibers only in areas that are very clean and do not contain sharp objects.</li> <li>◦ Wear finger cots or gloves as dirt and oils can damage the fiber and contaminate connectors.</li> <li>◦ Do not allow kinks or knots to develop in the fiber. If tangles occur, carefully work out the tangles avoiding pulling or bending the fibre beyond its bend radius.</li> <li>◦ Always use the correct tools for stripping and cleaving the fiber. It will save time and reduce breakage caused by scratches.</li> <li>◦ If you must secure a bundle of fiber cables together, avoid plastic and metal tie wraps; secure with Velcro instead.</li> </ul>
6. Disposing of the unit	<ul style="list-style-type: none"> <li>◦ Dispose of the unit and its components (including batteries) as specified by all national laws and regulations.</li> </ul>

## Product end-of-life disassembly instructions

For disassembly instructions, please call the technical support in order to remove components requiring selective treatment, as defined by the EU WEEE Directive (2012/19/EU). See [Harmonic Technical Assistance Center contact information](#) on page 19.

1. Disassemble equipment at a dedicated area only, gather the needed tools for disassembly.
2. Remove covers, housing, etc.
3. Remove and separate sub-assemblies (i.e. cables, metals, displays, fans, etc.).

4. Separate hazardous materials from the remainder of the material.
  - a. Sort hazardous materials into their different types (i.e., batteries, hazardous liquids, hazardous solids, fiberglass, etc.).
  - b. Proceed with hazardous waste management processes only.
5. Identify re-usable materials/sub-assemblies and separate these from the rest of the material.
6. Identify and separate recyclable materials as per below examples:
  - a. Scrap material to be sent to smelter(s).
  - b. E-waste such as displays, CPU's, cables and wires, hard drives, keyboards, etc.
  - c. Metals such as steel, brass, and aluminum.
  - d. Plastics such as fan casings, housings, covers, etc.
  - e. Fiber optics and plastic tubing not containing electrical or data wiring.

## Safety rules (English)

Recycler personnel are to wear personal protective equipment including proper eye protection, proper hand protection, and proper breathing protection if needed.

Recycler personnel shall be experienced with using the proper tools required for disassembling equipment. Untrained personnel shall not disassemble Harmonic products. Unfamiliarity with tools can cause damage and injury.

## Règles de sécurité

Le personnel du recycleur doit porter de l'équipement de protection individuelle, y compris des lunettes, des gants et un masque de protection appropriés au besoin.

Le personnel du recycleur doit avoir de l'expérience des outils de démontage de l'appareil. Les produits Harmonic ne doivent pas être démontés par du personnel non qualifié. Une mauvaise connaissance des outils peut causer des dommages et des blessures.

## EU manufacturer's Declaration of Conformity

This equipment is in compliance with the essential requirements and other provisions of Directives 73/23/EEC and 89/336/EEC as amended by Directive 93/68/EEC.



**NOTE:** For specifics, about which standards have been applied, refer to the Declaration of Conformity of the product on Harmonic website at [Product Regulatory Compliance](#) or contact Harmonic Compliance Team at [regulatory.compliance@harmonicinc.com](mailto:regulatory.compliance@harmonicinc.com)

## Electromagnetic compatibility notices – Class A

1. FCC verification statement (USA)

This device complies with Part 15 of the FCC Rules. Operation is subject to the following two conditions: (1) This device may not cause harmful interference, and (2) this device must accept any interference received, including interference that may cause undesired operation.

This equipment has been tested and found to comply with the limits for a Class A digital device, pursuant to Part 15 of the FCC Rules. These limits are designed to provide reasonable protection against harmful interference when the equipment is operated in a commercial environment. This equipment generates, uses, and can radiate radio frequency energy and, if not installed and used in accordance with the instruction manual, may cause harmful interference to radio communications. Operation of this equipment in a residential area is likely to cause harmful interference in which case users will be required to correct the interference at their own expense.

Connections between the Harmonic equipment and other equipment must be made in a manner that is consistent with maintaining compliance with FCC radio frequency emission limits. Modifications to this equipment not expressly approved by Harmonic may void the authority granted to the user by the FCC to operate this equipment and you may be required to correct any interference to radio or television communications at your own expense.

2. ICES-003 statement (Canada)

**English:** This Class A digital apparatus complies with Canadian ICES-003.

**French:** Cet appareil numérique de la classe A est conforme à la norme NMB-003 du Canada.

3. CE Declaration of Conformity (European Union)

This product has been tested in accordance too, and complies with the Low Voltage Directive (2014/30/EU) and EMC Directive (2014/35/EU). The product has been marked with the CE Mark to illustrate its compliance.

4. VCCI Class A warning (Japan)

この装置は、情報処理装置等電波障害自主規制協議会（VCCI）の基準に基づくクラスA情報技術装置です。この装置を家庭環境で使用すると電波妨害を引き起こすことがあります。この場合には使用者が適切な対策を講ずるよう要求されることがあります。

English translation of the notice above: This is a Class A product based on the standard of the Voluntary Control Council for Interference (VCCI) from Information Technology Equipment. If this equipment is used in a domestic environment, it may cause radio interference. When such trouble occurs, the user may be required to take corrective actions.

5. BSMI EMC notice (Taiwan)

**警告使用者：**  
**這是甲類的資訊產品，在居住的環境中使用時，可能會造成射頻干擾，在這種情況下，使用者會被要求採取某些適當的對策**

English translation of the notice above: This is a Class A Information Product, when used in residential environment, it may cause radio frequency interference, under such circumstances, the user may be requested to take appropriate counter measures.

6. Class A warning (Korea)

주의 A급 기기 이 기기는 업무용으로 전자파 적합 등록을 한 기기이  
오니 판매자 또는 사용자는 이 점을 주의하시기 바라며 만약  
잘못 판매 또는 구입하였을 때에는 가정용으로 교환하시기 바랍니다.

English translation of the notice above: This is a Class A device and is registered for EMC requirements for industrial use. The seller or buyer should be aware of this. If this was sold or purchased by mistake, it should be replaced with a residential-use type.

7. Class A statement (China)

中华人民共和国“A类”警告声明

声 明

此为A级产品，在生活环境中，该产品可能会造成无线电干扰。在这种情况下，可能需要用户对其干扰采取切实可行的措施。

English translation of the notice above: When labeled with the CCC marking, the product meets the applicable safety and EMC requirements for China. This is a Class A product. In a domestic environment this product may cause radio interference, in which case the user may be required to take adequate measures.



8. Class A warning – CISPR 22 (AS/NZS)

**Warning (English)** This is a class A product. In a domestic environment this product may cause radio interference in which case the user may be required to take adequate measures.







**Attention (French)** Il s'agit d'un produit de classe A. Dans un environnement local, ce produit peut entraîner des perturbations radioélectriques, auquel cas l'utilisateur devra éventuellement prendre des mesures adéquates.

## Product regulatory compliance markings

Table B-1: Regulatory compliance markings

Country/ region	Testing standard/ specification	Certification type	Regulatory mark name	Product marks
USA/ Canada	EN 60950-1:2006 +A11:2009 +A1:2010 +A12:2011;  CAN/CSA C22.2 No. 60950-1-07 +A1:2011/UL 60950-1:2011	Safety	NRTL (National Recognized Test Laboratory)	
USA/ Canada	FCC CFR 47 Part 15, Class A  ICES-003: Issue 5, 2012; Class A	EMC	FCC Class A Statement	<div style="border: 1px solid black; padding: 2px; font-size: 8px;">This device complies with part 15 of the FCC Rules. Operation is subject to the following two conditions: (1) This device may not cause harmful interference, and (2) this device must accept any interference received, including interference that may cause undesired operation.</div>
European Union	RoHS: EN 50581:2012;  EN55022:2010/ CISPR 22:2008;  EN55024:2010/ CISPR 24:2010;  EN61000-3-2: 2006 +A1:2009 +A2:2009;  EN61000-3-3: 2008; Class A	Safety and EMC	CE / Low Voltage Directive	
Germany	EN 60950-1;  EN60825-1 (for laser)	Safety	GS	



Country/ region	Testing standard/ specification	Certification type	Regulatory mark name	Product marks
Mexico	NOM-019- SCFI-1998	Safety	NOM	
Taiwan	CNS 14336-1:2010  CNS 13438:2006; Class A	Safety and EMC	BSMI Certification (RPC) Number & Class A Warning	 警告使用者： 此類中頻的資訊產品，在居住的環境中使用 時，可能會造成射頻干擾。在這種情況下， 使用者會被要求採取某些適當的對策。
Japan	VCCI V-3/2013.04; CISPR 22:2008, Class A	EMC	VCCI	
Australia and New Zealand	AS/NZS CISPR22:2009 +A1:2010; Class A	Safety	C-Tick	 NXXXXX
Korea	KN22 Class A and KN 24	EMC	KC	
China	GB4943.1-2011 GB9254-2008 GB17625.1-2012	Safety and EMC	CCC	
India	IS 13252 (Part 1): 2010	Safety	BIS Compulsory Registration	"Self Declaration - Conforming to IS 13252 (Part 1):2010, R- XXXXXXXXXX"

## Product environmental compliance

Harmonic manufactures high quality and innovative IT and telecommunications equipment, video delivery infrastructure solutions and services for its customers worldwide. Harmonic is committed to providing our

customers with safe and environmentally friendly products that are compliant with all relevant regulations, customer specifications, and environmental legislation, including the directives described below.

## EU RoHS

In July 2006, the European Union's (EU) Directive (2002/95/EC) on the Restriction of the use of certain Hazardous Substances (RoHS) in Electrical and Electronic Equipment (EEE) went into effect, and in July, 2011, the European Union's RoHS Recast Directive (2011/65/EU) also known as RoHS II entered into force.

Harmonic understands the environmental risks associated with the substances covered by the RoHS Directive and has committed to eliminating or reducing the use of these, as well as other environmentally sensitive substances in our products. Harmonic also continues to comply with the requirements under RoHS II.

For more information, please visit EU RoHS directive page at official EU website.

[http://ec.europa.eu/environment/waste/rohs\\_eee/legis\\_en.htm](http://ec.europa.eu/environment/waste/rohs_eee/legis_en.htm)

### Restricted substance statement

Harmonic products contain less than the permitted limits for the six restricted substances except where exemptions published in the RoHS2 Directive are applicable. This statement is based on vendor-supplied analysis or material certifications, and/or lab test results of the component raw materials used in the manufacture of Harmonic products.

Table B-2: Restricted substances

Restricted substance	Permitted limit
Cadmium (Cd)	< 0.01% <sup>[1]</sup>
Lead (Pb)	< 0.1%
Chromium (VI) (Cr (VI))	< 0.1%
Mercury (Hg)	< 0.1%
Polybrominated biphenyls (PBBs)	< 0.1%
Polybrominated diphenyl ether (PBDE)	< 0.1%

## EU REACH

REACH (Registration, Evaluation, Authorization and restriction of Chemicals) (EC 1907/2006) is a European Union's regulation on chemicals and their safe use which came into force in June, 2007.

Harmonic supports the basic aim of REACH in improving the protection of human health and environment through the better and earlier identification of intrinsic properties of chemical substances. Harmonic products are considered "articles" under REACH; therefore, we are required to provide recipients of our products with information on Substance of Very High Concern (SVHC) present in concentration above 0.1% (w/w).

Substances in our products are not intended to be released under normal or reasonably foreseeable conditions of use; therefore, the registration requirement in REACH Article 7(1) does not apply to our products.

<sup>1</sup> Homogeneous material definition as per the EU Directive.

For more information, please visit REACH regulation page at official EU website.

[http://ec.europa.eu/environment/chemicals/reach/reach\\_en.htm](http://ec.europa.eu/environment/chemicals/reach/reach_en.htm)

## China RoHS

China's regulation on restriction of the use of certain hazardous substances commonly (China RoHS), is applicable to all Electronic and Information Products (EIPs) and parts sold in China after March 01, 2007. China RoHS regulation restricts the use of the same six substances as the European Union's ROHS, but has requirements for product labeling and regulated substance information disclosure.

Harmonic complies with China RoHS Phase I for labeling and information disclosure requirements and continues to monitor new developments in China RoHS Phase II towards substance restriction and certification program.

For more information, please visit China RoHS regulation page at official US export website.

<http://www.export.gov/china/doingbizinchina/>

### China RoHS Disclosure report

Below table shows the presence of hazardous substances, or elements in Harmonic products, if the part is present.

该表显示哈雷公司产品中可能含有的有毒有害物质元配件的信息，除了来源于元配件供应商的物料成分资料，亦来自其它相关的机构与资料。哈雷产品不一定使用这些元配件。

This table shows those components where hazardous substances may be found in Harmonic products based on, among other things, material content information provided by third party suppliers. These components may or may not be part of the product.

除非特殊注明，哈雷公司产品的环保使用期限均为 20 年。该环保使用期限的有效条件为：必须遵循该产品使用手册的规定，对该产品进行使用或存储。

The Environmental Protective Use Period (EPUP) for Harmonic products is 20 years unless displayed otherwise on the product. The EPUP period is valid only when the products are operated or stored as per the conditions specified in the product manual.

部件名称 (Part name)	有毒有害物质或元素 (Hazardous substance)					
	铅 (PB)	汞 (Hg)	镉 (Cd)	六价铬 (CrVI)	多溴联苯 (PBB)	多溴二苯醚 (PBDE)
印刷线路板 (Printed circuit assemblies)	X	O	O	O	O	O
机械组件 (Mechanical subassemblies)	X	O	O	O	O	O
光学组件 (Optical subassemblies)	X	O	O	O	O	O
电源 (Power supplies)	X	O	O	O	O	O

部件名称 (Part name)	有毒有害物质或元素 (Hazardous substance)					
	铅 (PB)	汞 (Hg)	镉 (Cd)	六价铬 (CrVI)	多溴联苯 (PBB)	多溴二苯醚 (PBDE)
缆线 / 线束 (Cables, harnesses)	X	O	O	O	O	O
屏幕 / 显示器 (Screens, monitors)	X	O	O	O	O	O
金属零件 (Metal parts)	X	O	O	O	O	O
塑料 / 发泡材料 (Plastics, foams)	O	O	O	O	O	O
电池 (Batteries)	O	O	O	O	O	O

O: 表示在该部件的所有均质材料中，此类有毒有害物质的含量均小于SJ/T11363-2006标准所规定的限量。

O: Indicates the content of the toxic and hazardous substances at the homogeneous material level of the parts is below the limit defined in SJ/T11363 2006 standard.

X: 表示至少在该部件的某一均质材料中，此类有毒有害物质的含量超出SJ/T11363-2006标准规定的限量。

X: Indicates that the content of the toxic and hazardous substances in at least one of the homogeneous materials of the parts is above the limit defined in SJ/T11363 2006 standard.

## Other RoHS and REACH type regulations

Harmonic will comply with RoHS and REACH type regulations evolving in other countries, if they become relevant to our products or in markets where we sell our products.

## Waste Electrical and Electronic Equipment (WEEE)

European Parliament and the Council of the European Union's WEEE Directive (2002/96/EC) came into force on August, 2005 and, were more recently amended in July, 2012. This directive encourages the reuse, recycling, and recovery of WEEE and to improve the environmental performance of all operators involved in the life cycle of electrical and electronic equipment, especially those dealing with WEEE. Harmonic ensures that all requirements for registration, reporting, design and data tracking are complied with to meet the objectives of the WEEE directive.

For more information, please visit WEEE directive page at official EU website: [http://ec.europa.eu/environment/waste/weee/legis\\_en.htm](http://ec.europa.eu/environment/waste/weee/legis_en.htm)

## Battery directive

In September 2006, the European Union's Directive 2006/66/EC (Battery Directive) came into force with an aim to prohibit the sale of batteries and accumulators containing hazardous substances and to set rules and promote collection, treatment, recycling and disposal of waste batteries and accumulators. This directive applies to spent batteries collected together with WEEE and requires their removal and separate collection. Once removed from WEEE, spent batteries are governed by the Battery Directive. Harmonic

uses lithium batteries in its products and our responsibility under the Battery Directive is taken care of under our WEEE Take-Back program.

For more information, please visit Batteries and Accumulators directive page at official EU website.

<http://ec.europa.eu/environment/waste/batteries/>

Harmonic is committed to manufacturing environmentally safe products for the community, and will make reasonable efforts and required adjustments to its practices, if necessary, to comply with various environmental directives and industry initiatives on the elimination of hazardous substances, labeling, marking, certification and registration as required in markets where we sell our products.

Download Harmonic Environmental Compliance Statement at the following location:

<http://www.harmonicinc.com/content/green-policy>

## WEEE Take-Back Request Program

In order to assist EU member states to preserve, protect and improve the quality of the environment, protect human health and utilize natural resources prudently and rationally, Harmonic strives to recycle in compliance with the WEEE Directive any of its products that cannot be re-used.

Harmonic's customers should:

- Not discard equipment in household or office garbage
- Arrange proper recycling of unneeded equipment. For the take-back of Harmonic equipment, customers must:
  - Collect the information required to complete Harmonic's WEEE Take-Back Request form
  - Complete and submit the online WEEE Take-Back Request form. Please note that forms must be fully completed in order to prevent process delays
  - Receive instant online confirmation indicating the reference number
  - Receive the End of Life (EOL) asset return authorization number and instruction for EOL asset return
- Not ship EOL product to Harmonic without a Harmonic-provided EOL asset return authorization number

The crossed-out wheeled bin symbol on a Harmonic-branded commercial product indicates that the product should not be disposed of along with municipal waste, but invites our customers to return the product to us under Harmonic's WEEE Take-Back program for product disposal.

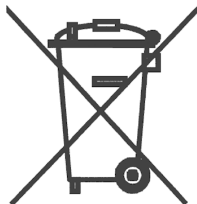

Harmonic will pay for the cost of shipping and will provide a Certificate of Recycling or a Certificate of Destruction upon request. For more information on collection, reuse and recycling or to initiate the WEEE take-back process, please complete the form at <http://www.harmonicinc.com/webform/weee-takeback-request> or contact [Harmonic Technical Assistance Center \(TAC\)](#) or email RMA team at [rma.emea@harmonicinc.com](mailto:rma.emea@harmonicinc.com).

## Compliance with additional country specific environmental, safety and EMC standards:

In addition to above listed standards and compliance regulations, Harmonic products may also be compliant with other country specific environmental, safety and EMC requirements. Please contact Harmonic Compliance Team at [regulatory.compliance@harmonicinc.com](mailto:regulatory.compliance@harmonicinc.com) or your local sales representative for more information about compliance with particular country or standard.

